

LEDON®

No. 440 - Flower

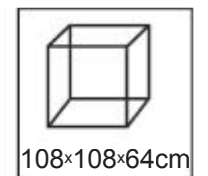

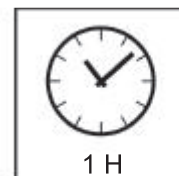

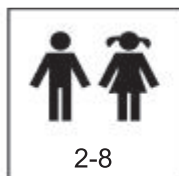
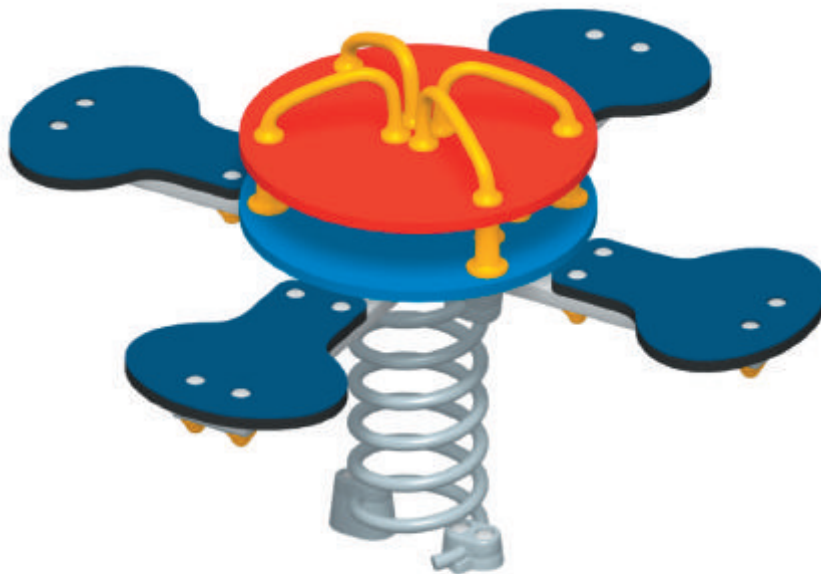
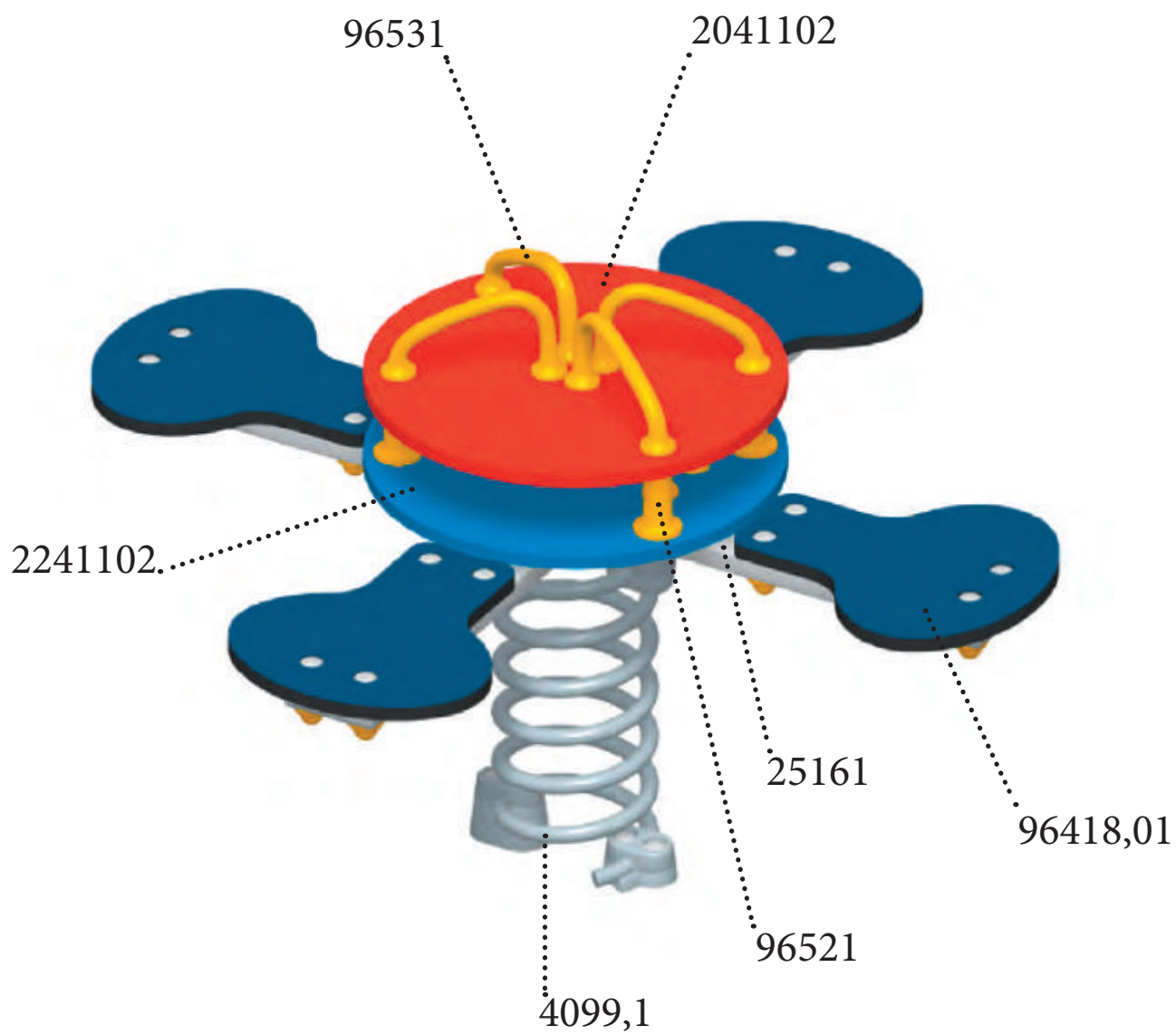

Faldunderlag: I overensstemmelse med EN 1177

Safety surface: In accordance with EN 1177

Fallschutzbelag: Gemäß EN 1177





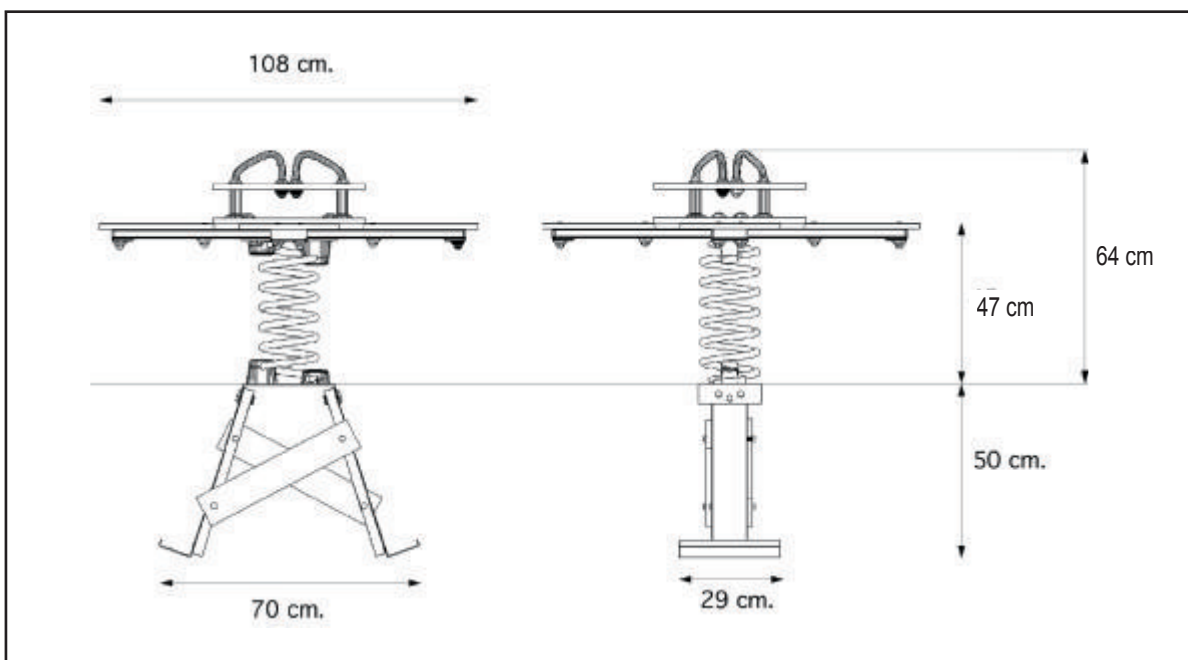
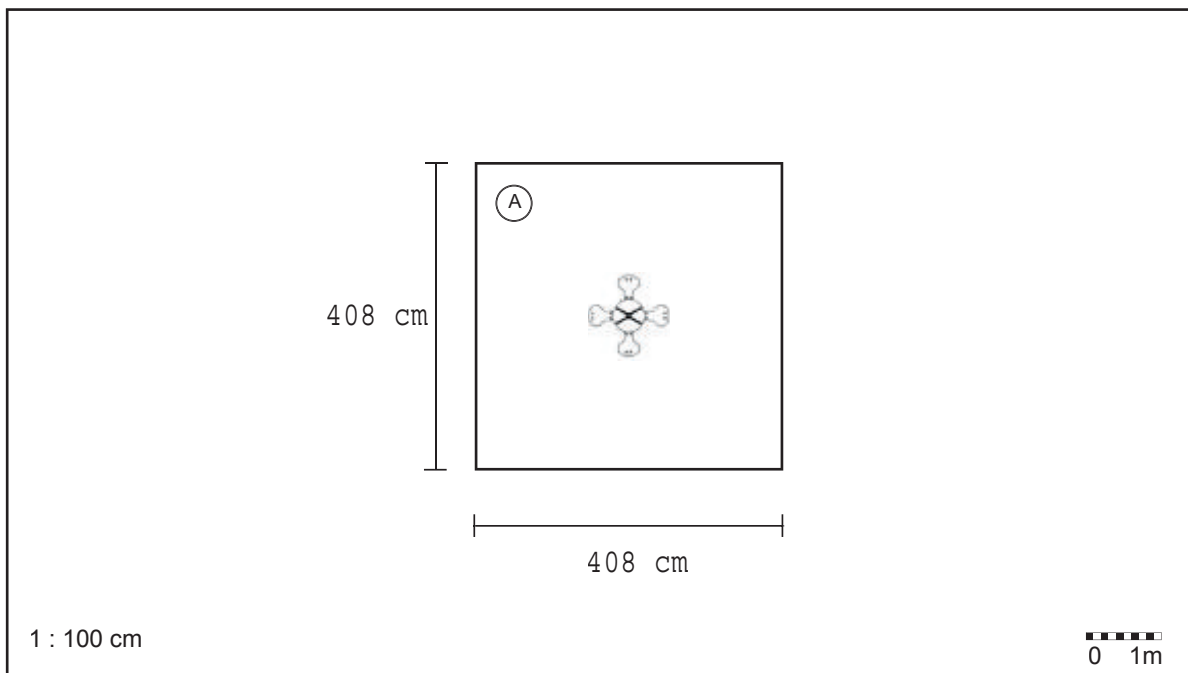

Zone D'impact d'après norme EN 1177

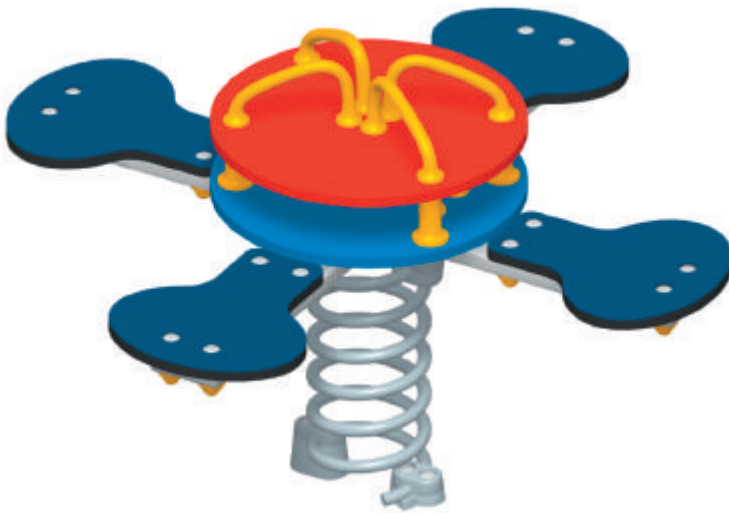
Fundamento de caída según norma EN 1177

		
(A)	78 cm	16,7 m2





4 Pcs.		10x65 BB A2
4 Pcs.		LM 10
4 Pcs.		GSB
4 Pcs.		GT
2 Pcs.		LM 6
2 Pcs.		M6x16 Pin TX 30
1 Pcs.		TK 30
2 Pcs.	